



Work with two person so that the product does not bend.

Keep the followings to prevent damages, electric shock, fume and fire.

■ Work Alone

NG!

The circuit board inside the product will be broken!

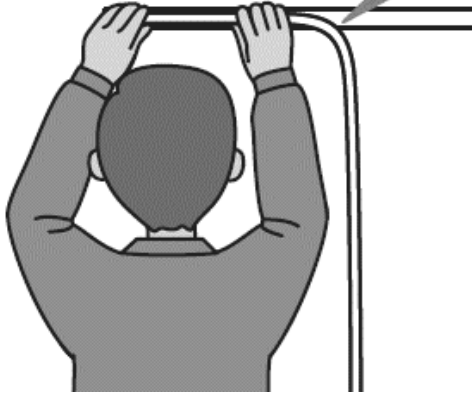

The product may bend and cause open circuit.

■ Work Two-Person

OK

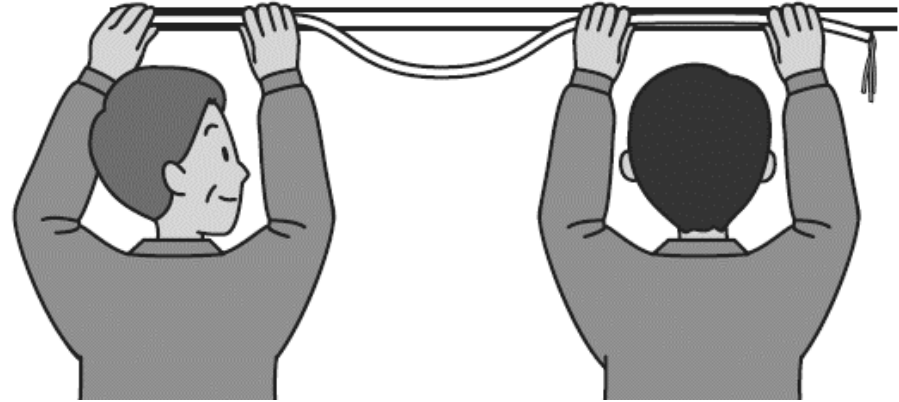

Support the product so that it does not bend.

If it is necessary to work alone, be careful not to bend the product over your shoulders.



Caution when Installing the Product

Keep the followings to prevent damages, electric shock, fume and fire.

Do not connect to AC power.

NG!

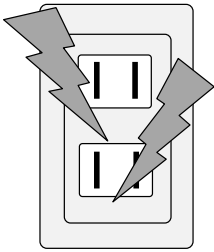

Do not use a tool with sharp point.

NG!

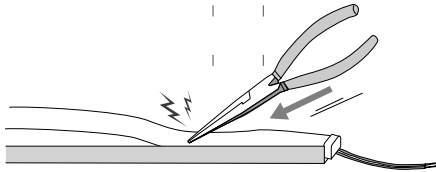

Do not tramp on or strike the product.

NG!

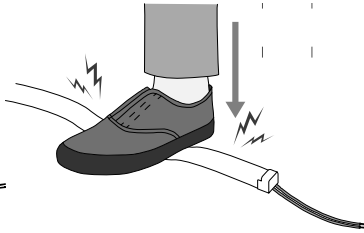

Do not pull out the product diagonally from the channel.

NG!

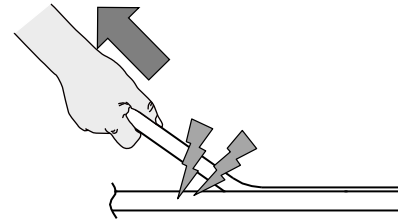

NG!

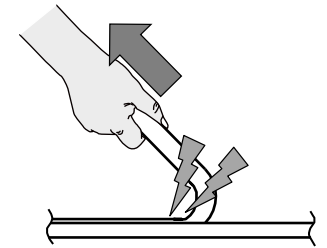

Do not separate the channel at the gap of mounting base.

NG!

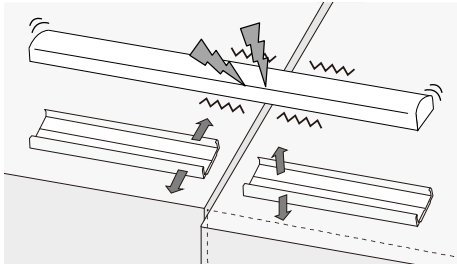

Vibration or misalignment of the base may cause a break of the product!

OK

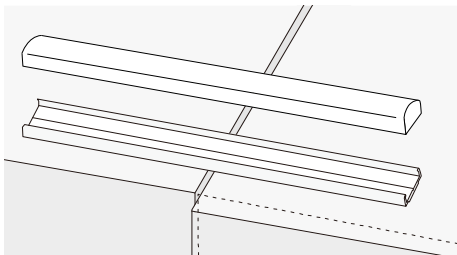

The channel can suppress vibration and misalignment of the base, and prevents the break of the product.

Do not bend the product toward horizontal direction.

NG!

Horizontal direction

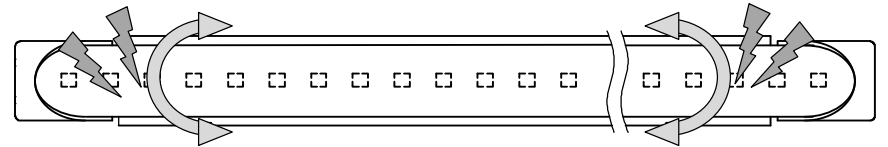

OK

Vertical direction.
Bending radius is 150 mm or more.

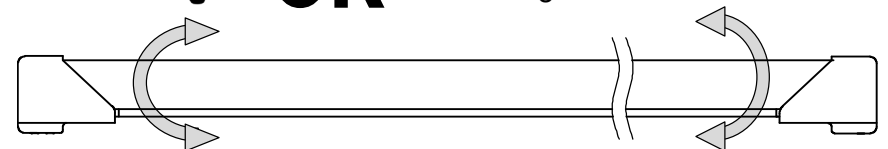

Tsubaki Seamless Light Type V Addressable Instruction Manual

For Keeping

atex

We will appreciate for your purchasing the product. Please carefully read this manual to install the product correctly and safely. After reading them, preserve them carefully for future reference.

ZTE3TLADR Ver.20240419

WARNING

Read this section carefully to prevent electrical shock, fire and other hazard.

- Qualifications are required to do electrical works. Check the laws of your country.
- Input voltage is 24V DC only. Do not apply other voltage such as AC power.
- Do not disassemble or alter the product.
- Turn off the power before installing or handling the product.
- Do not put screws into the products directly. It will cause damages. Please refer to "Installation Method".
- Do not perform the following actions on the product.
 - Excessive bending and twisting of the product.
 - Dropping and strongly striking the product.
- Do not install or handle the product with wet hands.
- This product should not be installed in the following places.
 - Places where water is continuously splashed or underwater. (This product is IP67 rated)
 - Places where moisture tends to remain.
 - Places with poor heat dissipation.
 - Places with high temperature and humidity, such as bathrooms and saunas.
 - Places with large vibrations and shocks.
- Clean and inspect the product on a regular basis. Leaving the product for a long period of time may cause smoke, fire, or electric shock.
 - Voluntary inspection and cleaning (once a year).
 - Inspection and cleaning by specialists such as an electrician (once every three years).
- If there is any trouble with the product, please immediately turn off the power and contact the dealer or installer.

CAUTION

- Please be careful that eyes might be hurt when you look straight at light emitting part.
- Please be careful about static electricity. It will damage the product.
- The product is vertical bending type. Please do not bend the product toward horizontal direction. It may cause the failure.
- Do not install the lead wires with tension. It may cause the failure.
- The temperature rise of the product is influenced with the capacity and the distance from housing. Ambient temperatures must remain the product specification.
- The product cannot be used in the atmosphere of corrosive gas and flammable gas, like the following.
 - Area with synthetic rubbers, cardboards, and other materials containing Sulphur.
 - Area with hot springs containing Sulphur.
- Even if the bending is looser than the minimum bending radius (R150mm), repeated bending of the product may cause a malfunction. Do not bend the product more than 5 times, including attaching to the channel. Also, do not attach it to doors that open and close.

Specification

This product is a diffuser type tape light with a built-in DMX drive circuit, and can be controlled in full color by directly connecting a DMX controller.

Product Specification

Product Name			
Tsubaki Seamless Light Type V Addressable			
Pitch Type	Fine Pitch	Standard Pitch	Long Pitch
Product No.	TLD-ADR-F	TLD-ADR-S	TLD-ADR-L
Length	114mm ~ 1026mm + End-caps 10mm		171mm ~ 1026mm + End-caps 10mm
Size	Refer to dimensional drawing.		
Weight	340g/m		
Input Voltage	DC24V		
Power Consumption	13W/m	12W/m	
Color *1	Red, Green, Blue		
Luminous Flux	Red:110 lm/m, Green:260 lm/m, Blue:50 lm/m		
Bending Radius	R150 mm Vertical		
Dimming Signal Standard	DMX512 Standard		
Compatible DMX Controller	DMX Controller Conforming to DMX512 Standard * Please contact our sales for recommended models.		
DMX Address	From the beginning, 1ch: R / 2ch: G / 3ch: B ... will be addressed automatically. When concatenated, DMX addresses will be consecutive from the unit in front.		
DMX Control Length	57mm Unit	114mm Unit	171mm Unit
Used DMX Channels	54 channels/m	27 channels/m	18 channels/m
Max DMX Drive Length	9,690mm (57mm×170 modules)	19,380mm (114mm×170 modules)	29,070mm (171mm×170 modules)
Max Unit Connectable *2	6.2m (1026mm×6) *If you connect more products, the brightness and color will vary greatly.		
Operating Temperature Environment	-10 ~ +55°C Indoor / Outdoor (IP67 rated)		

*1 Please note that there is some variation in color among LED's.

- The white of RGB LED, and the white of single-color LED's is different in hues.
- The balance of emitted light color may change over time.

*2 The connection length of the product is also limited by the power supply.

Options

Part Name	Part Number	Note
Aluminum Rigid Channel	FAS00-01TDA	Length=1000mm
Aluminum Mounting Bracket	FATDA-HA	Length=36mm, including spring, 5pcs per pack Please use 5pcs per meter.
DMX Input Cable for XLR3	WCADR-XLR3C	Length=1000mm, w aterproof type except XLR3
DMX Input Cable for XLR5	WCADR-XLR5C	Length=1000mm, w aterproof type except XLR5
DMX Input Cable for RJ45	WCADR-RJ45C	Length=1000mm, w aterproof type except RJ45
DMX Relay Cable	WCADR-DMXRC	Length=1000mm, w aterproof type
Power and DMX Relay Cable	WCADR-DCDMXRC	Length=1000mm, w aterproof type, VCTF 2sq-4C

- For the usage, refer to the "Installation Method" and "Wiring Method" sections.

DMX Controller (Sold separately)

Please contact our sales representative for suitable DMX controllers.

Dimensions

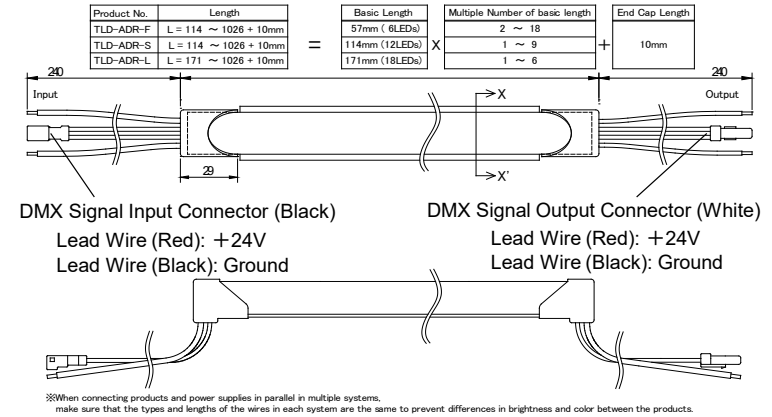

[Bottom (Enlarged View)]

- One circuit is 57mm and controls 6 LEDs. Third-angle projection method (Unit : mm)
- Depending on the number of circuits controlled by the DMX drive IC, the DMX drive length (module length) is Fine:57mm, Standard:114mm or Long:171mm pitch.

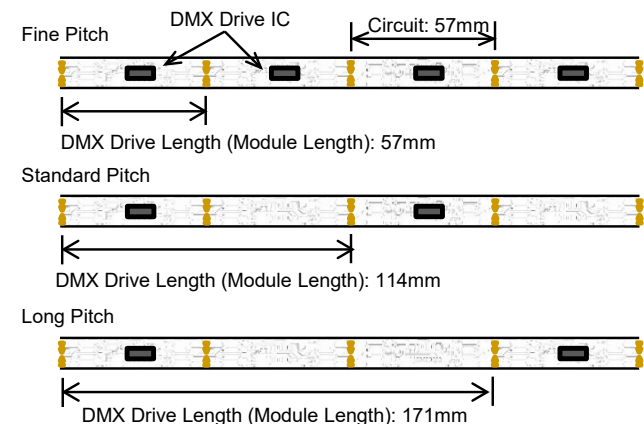

System Diagram (Example)

[DMX]

3 channels (1ch: red / 2ch: green / 3ch: blue) are used in one DMX drive circuit (module).

Up to 170 modules can be controlled by one DMX system. When you need more than 171 modules of color control, use multiple DMX systems (universes) to control them.

[Power Supply]

This products can be connected according to the power output capacity of a power supply, but the maximum series connection length should be 6.2 m or less. If the maximum series connection length is exceeded, connect in parallel from the power supply.

Ex.) Fine Pitch / 1026mm (18 modules) ... $13W/m \times 1026mm + 1000mm = 13.4W$ and 240W Power Supply

- DMX: Since $18modules \times 3ch = 54ch$ are used, 9 products can be connected in 1 universe (512ch).
- Power Supply: You can connect up to $240W \div 13W/m = 18.4m$, but since the maximum series connection length is 6.2m, connect every 6 products in parallel.

In this example, the DMX signal and power supply are divided into 6 systems for easy understanding.

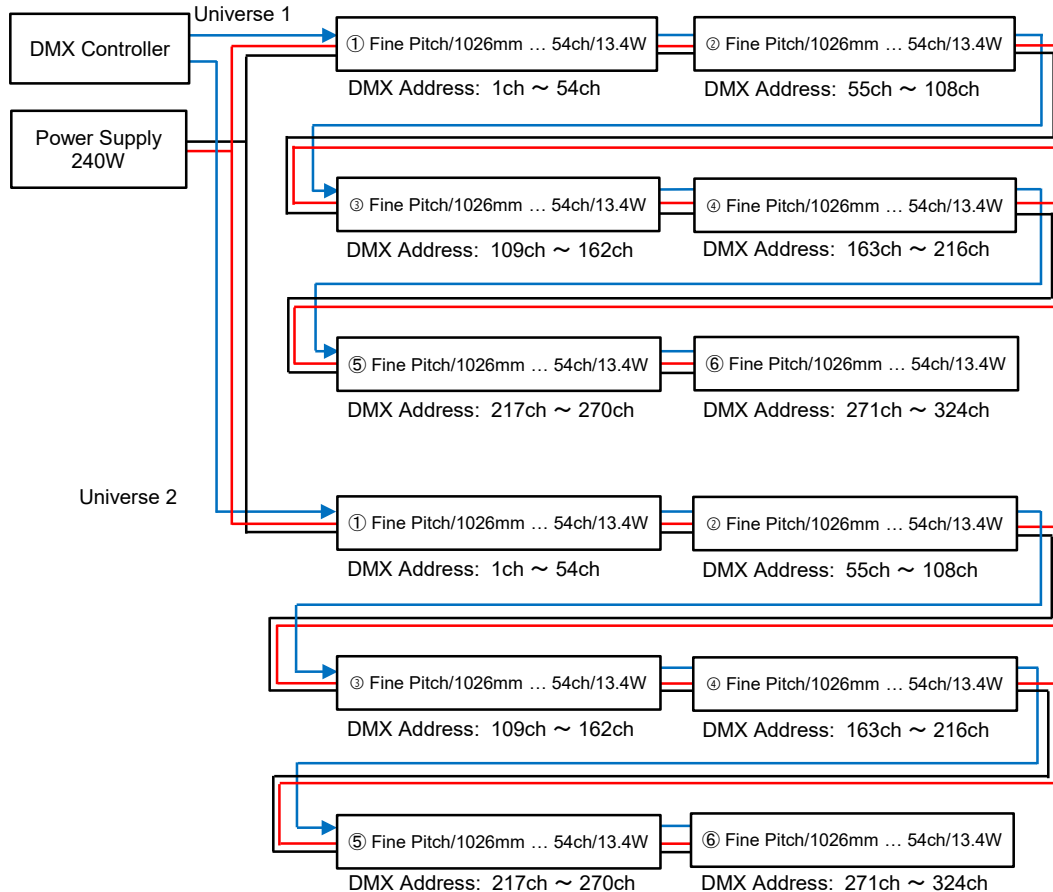

- Perform a matching test with the DMX controller in advance.
- When connecting products and power supplies in parallel in multiple systems, make sure that the types and lengths of the wires in each system are the same to prevent differences in brightness and color between the products.

Wiring Method

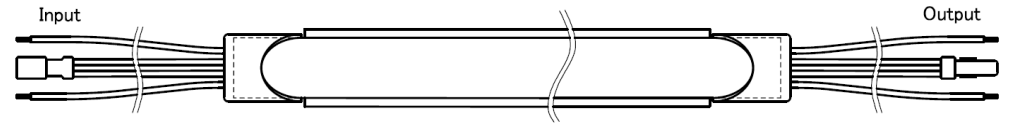

[Input]

- Lead Wire (Red) → Connect to DC24V +/
- Lead Wire (Black) → Connect to Ground of DC24V.
- DMX Signal Input Connector (Black) → Connect to DMX Controller.

※ When connecting to a DMX controller, use the optional input cable below.

[Output]

- When connecting to the next product
 - Lead Wire (Red) → Connect to the red lead wire of the next product.
 - Lead Wire (Black) → Connect to the black lead wire of the next product.
 - DMX Signal Output Connector (White) → Connect to the DMX signal input connector (Black) of the next product.
- When not connected
 - Insulate properly so that the red and black lead wire do not short-circuit.

[Optional DMX Input Cable]

Use an input cable that matches the DMX signal output connector on your DMX controller.

- DMX Input Cable for XLR3 (WCADR-XLR3C) ... for DMX output connector is an XLR-3 female

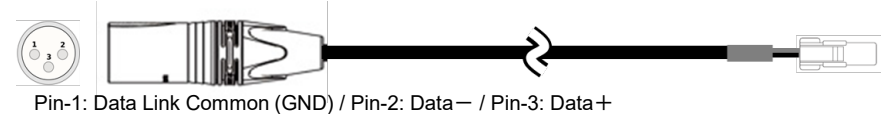

- DMX Input Cable for XLR5 (WCADR-XLR5C) ... for DMX output connector is an XLR-5 female

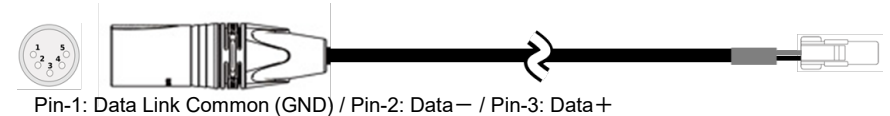

- DMX Input Cable for RJ45 (WCADR-RJ45C) ... for DMX output connector is a RJ45

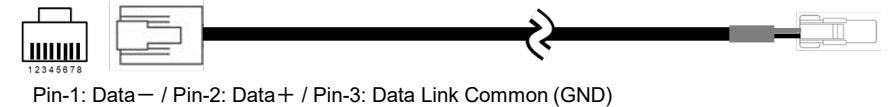

[Optional Relay Cable]

Use a relay cable when connecting the products apart.

- DMX Relay Cable (WCADR-DMXRC) ... for extending the DMX signal

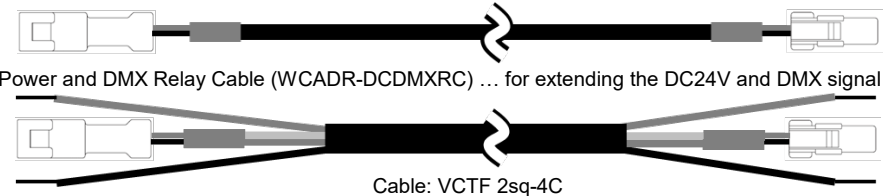

- When using its outdoors, waterproof the connection of the DC24V lead wire.
- The standard length of the cable is 1m. For other lengths, please contact our sales representative.

Installation Method

■ Straight line installations

- 1 Please cut the Aluminum Rigid Channel (FAS00-01TDA) as needed.
- 2 Remove the burr after cutting the channel, because the burr may cause damages, electric shock and smoke.
- 3 Securely mount the channel on the wall using screws and screw holes.
 - Please use the appropriate screws according to the wall so that the channel and the product will not fall.
- 4 Put and push the product into the channel securely.
 - Insert the product ribs securely below the channel ribs.
- 5 Attach the Fixing Spring over the product into the groove of the channel, and between the leaf springs of the holder attached backside the channel.

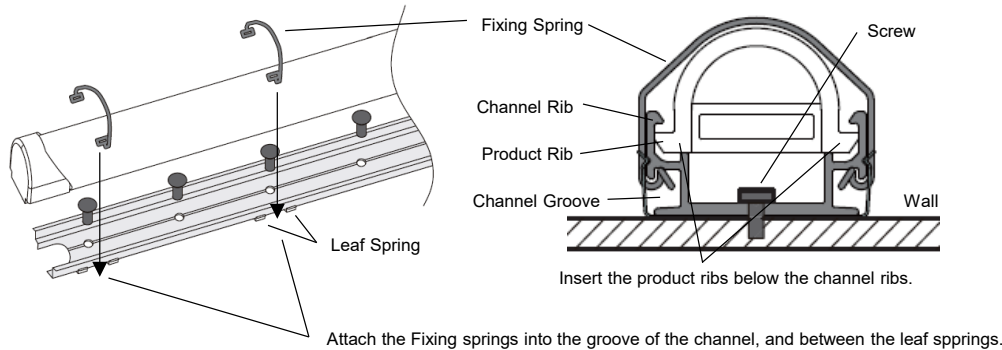

- 6 After attaching the fixed springs, pull them to make sure they are completely fixed in the channel grooves. Otherwise, the product may be dropped off from the the channel.

CAUTION

- We DO NOT recommend to remove the product from the channel after the installation. Repeated installation and removing may causes failure.
- If you have to remove the product from the channel, lift up the product carefully and slowly, and pull it out vertically within 45 degrees with your hands.

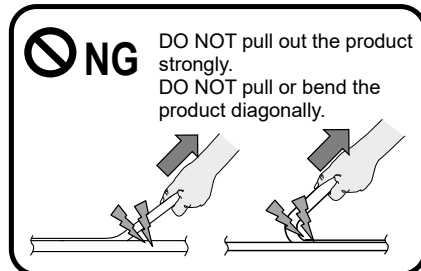
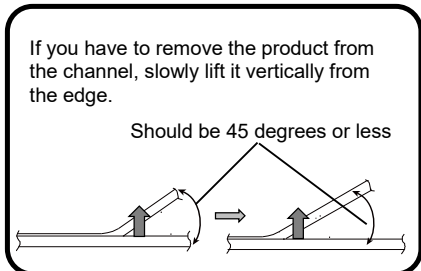

Installation Method

■Curvy line installations

- Use Aluminum Mounting Bracket, FATDA-HA.
- 1 Securely mount the bracket on the wall using screw and the screw hole.
 - Please use the appropriate screw according to the wall so that the bracket and the product will not fall.
 - 2 Put and push the product into the bracket securely.
 - Insert the product ribs securely below the bracket ribs.
 - 3 Attach the Fixing Springs over the product into the grooves of the brackets, and between the leaf springs of the holder attached backside of the bracket.

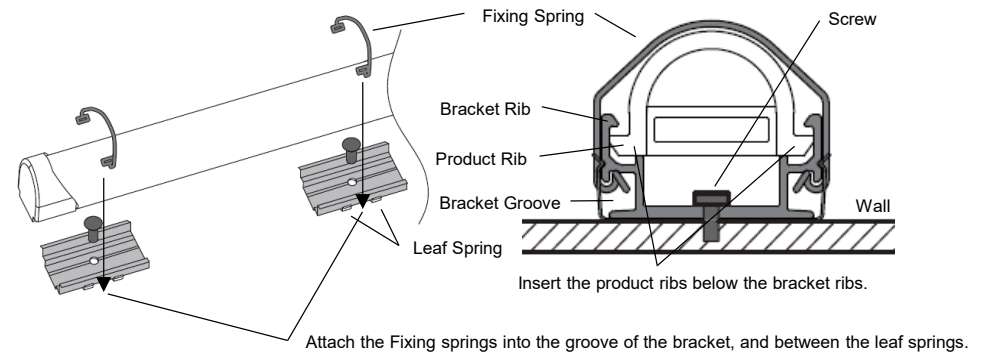

- 4 After attaching the fixed springs, pull them to make sure they are completely fixed in the bracket grooves. Otherwise, the product may be dropped off from the the bracket.

CAUTION

- Use Atex accessories to install the product.
- Do not put the screw on the product directly. It may cause damages.
- Do not use double sided tape and glue to install the product.
- Do not perform the excessive bending or twisting of the lead wires and End Caps. It may cause the failure and the decline in water resistant performance.
- In case of installing the product vertically, it may be slid down. As the right figure, set the L-shape metal corner brace beneath the product. Do not pinch the leads by the brace to prevent fire.

