

Caution when Installing the Product

Keep the followings to prevent damages, electric shock, fume and fire.

Do not connect to AC power.

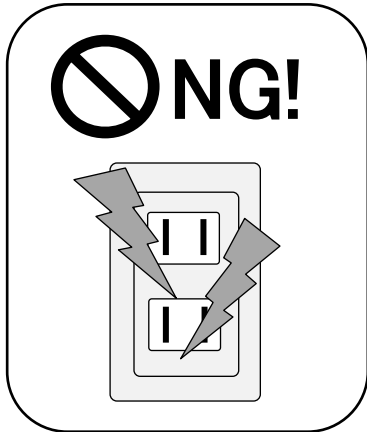

Do not use a tool with sharp point.



Do not tramp on or strike the product.



Do not pull out the product diagonally from the channel.

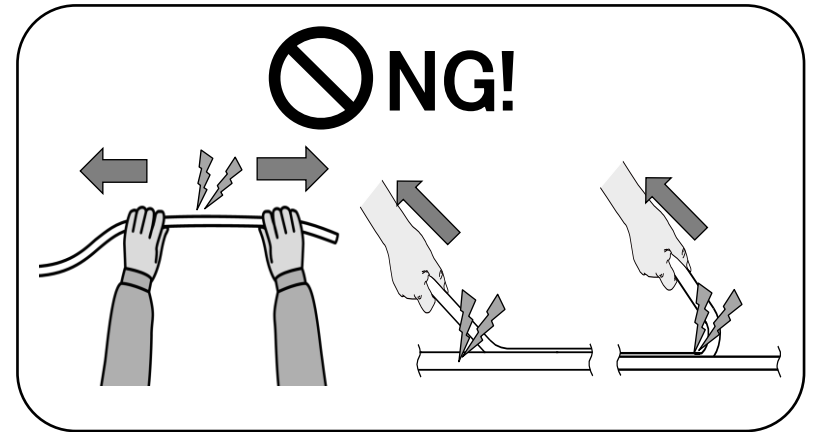

Do not separate the mounting channels at the gap (joint parts) between mounting bases.

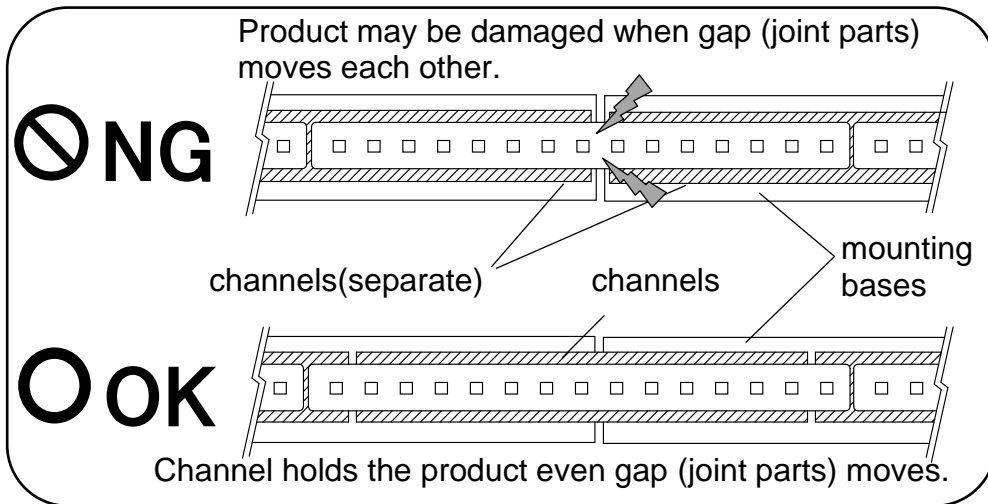

Do not bend the product toward vertical direction.

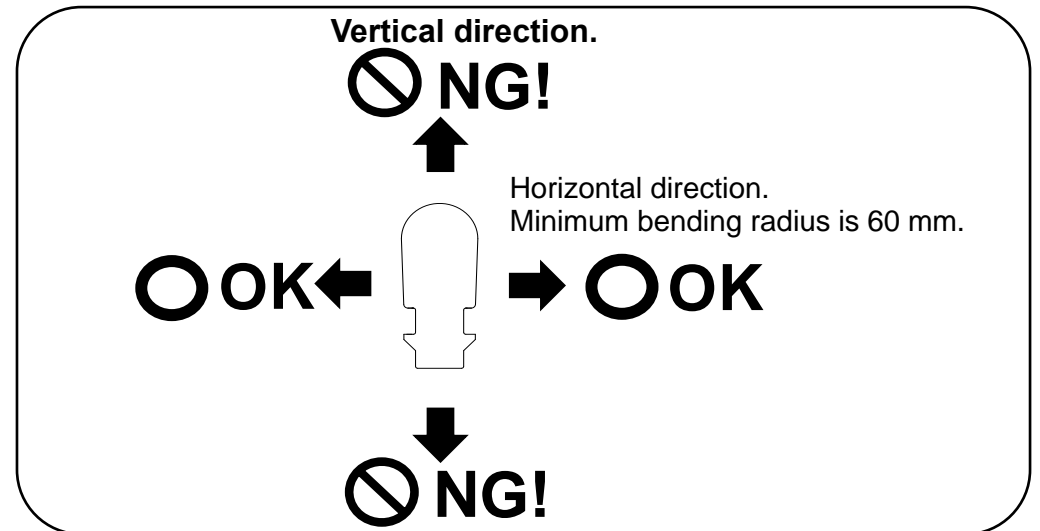

Tsubaki Seamless Light Type H RGB color (GLD-F) Instruction Manual

We will appreciate for your purchasing the product. Please carefully read this manual to install the product correctly and safely.
The contents described on this manual are subject to change without prior notice.

atex

Atex Co.,Ltd.

For Keeping

ZTE2GLDF

Ver.220720

WARNING

Read this section carefully to prevent electrical shock, fire and other hazard.

- Electrical works certificate is required to install and inspect this product.
- Input voltage is 24V DC only. Do not apply other voltage such as AC power.
- Do not disassemble or alter the product.
- Turn off the power before installing or handling the product.
- Do not put screws into the products directly. It will cause damages. Please refer to "Installation Method".
- Please do not perform the following actions on the product.
 - Excessive bending and twisting of the product.
 - Dropping and strongly striking the product.
- Do not install or handle the product with wet hands.
- This product should not be installed in the following places.
 - Places where water is continuously splashed or underwater. (This product is IP67 rated)
 - Places where moisture tends to remain.
 - Places with poor heat dissipation.
 - Places with high temperature and humidity, such as bathrooms and saunas.
 - Places with large vibrations and shocks.
- Clean and inspect the product on a regular basis. Leaving the product for a long period of time may cause smoke, fire, or electric shock.
 - Voluntary inspection and cleaning (once a year).
 - Inspection and cleaning by specialists such as an electrician (once every three years).
- If there is any trouble with the product, please immediately turn off the power and contact the dealer or installer.

CAUTION

- Please be careful that eyes might be hurt when you look straight at light emitting part.
- Please be careful about static electricity. It will damage LED's.
- The product is vertical bending type. Please do not bend the product toward horizontal direction. It may cause the failure.
- Do not pull the lead wire strongly. It may cause the failure.
- The temperature rise of the product is influenced with the capacity and the distance from housing. Ambient temperatures must remain the product specification.
- The product cannot be used in the atmosphere of corrosive gas and flammable gas, like the following.
 - Area with synthetic rubbers, cardboards, and other materials containing Sulphur.
 - Area with hot springs containing Sulphur.

- Even if the bending is looser than the minimum bending radius (R60mm), repeated bending of the product may cause a malfunction. Do not bend the product more than 5 times, including attaching to the channel. Also, do not attach it to doors that open and close.

Specification

■ Product Specification

Product Name	Tsubaki Seamless Light Type H RGB color
Product No.	GLD-F
LED Color *1	Red, Green, Blue
Input Voltage	DC24V ±5%
Power Consumption	10W/m
Operating Temperature	-10 ~ +55°C (IP67 rated. Indoor / Outdoor)
Dimension	Refer to dimensional drawing.
Weight	250g/m
Minimum Bending Radius	R60 mm, horizontal.
Maximum Series Connection Length *2	10.1m (5016mm x 2 + End-caps)
LED Pitch	9.5mm

*1 Please note that there is some variation in color among LED's.

*2 The connection length of the product is also limited by the power supply and DMX driver.

■ Options

Product Name	Product No.	Remarks
Aluminum Channel for straight line	FAS00-01GD	L=1m
Aluminum Channel for flexible line	FAC20-01GD	L=1m
End cap	EC109-02	

Aluminum
Channel for
straight line

FAS00-01GD

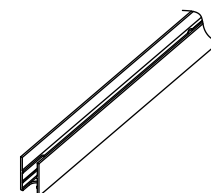

Aluminum
Channel for
flexible line

FAC20-01GD

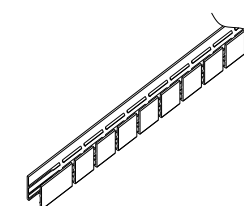

- Please contact our sales representative for suitable DMX controllers.

■ Dimension

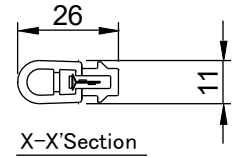
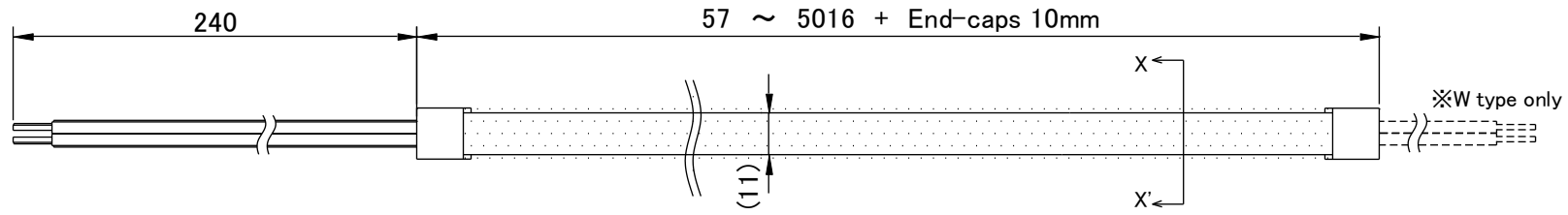

Cable color means below.

- White cable: +24V
- Red cable: Red
- Green Cable: Green
- Blue Cable: Blue

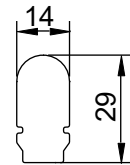
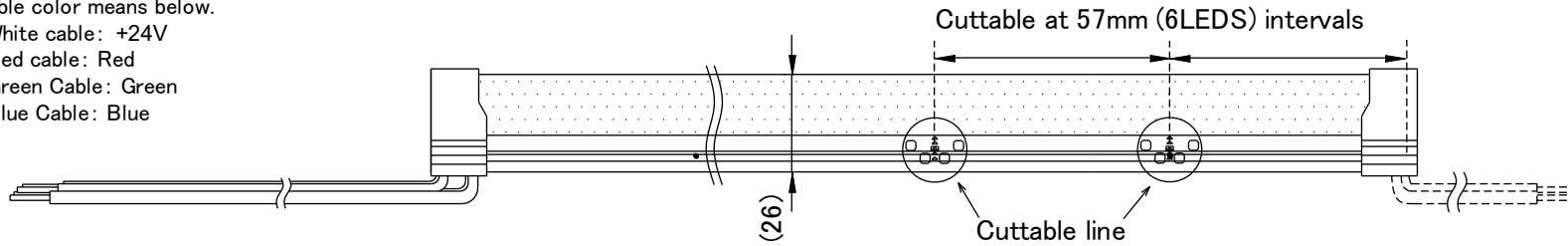

Cuttable width

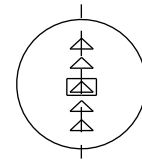
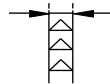

Enlarged view of
Cuttable line

Note:

When connecting products and power supplies in parallel in multiple systems, make sure that the types and lengths of the wires in each system are the same to prevent differences in brightness and color between the products.

Third-angle projection method (Unit : mm)

Wiring Method

■ Maximum series connection length

- The product length to be connected in series should be 10.1 m or less.

■ Limits of current value and wire

- Use the power supply and DMX Driver that has enough power to drive the products. The following is a connectable products length, when you use Linear Drive as DMX Driver.

DMX driver	Connectable products length to DMX driver	Remarks
LIN180D3	When you connect the products in parallel, you can connect them up to 10.3 m. Please note that the series connection length of the products should be 10.1 m or less.	LED output load: RGB @ 24V: 2A
LIN720D3	When you connect the products in parallel, you can connect them up to 31.0 m. Please note that the series connection length of the products should be 10.1 m or less.	LED output load: RGB @ 24V: 6A

- Use appropriate wires.

- Check the wire specifications of the power supply and DMX driver.
- Keep the wires as short as possible.
- The total wire length of series connections of 24V DC and LED output is limited by the size of the wire and length of the products. Refer to the following list.

Wire			Product length	Recommended maximum total wire length of series connections of 24V DC and LED output.
Size		Ampacity		
S-VCTF0.5sq-4C	AWG 20	7 A	10.1 m	Up to 10 m
			5.0 m	Up to 20 m
S-VCTF0.75sq-4C	AWG 18	9 A	10.1 m	Up to 15 m
			5.0 m	Up to 30 m
S-VCTF1.25sq-4C	AWG 16	12 A	10.1 m	Up to 25 m
			5.0 m	Up to 50 m

※ These values of ampacity are examples only. Refer to the specifications of wires you use.

※ When connecting products and power supplies in parallel in multiple systems, make sure that the types and lengths of the wires in each system are the same to prevent differences in brightness and color between the products.

- Please contact our sales representative for more information of wiring.

■ Example of wiring

- Follow the documents of dimming controller, power supply and DMX Driver that you use.
- Follow the specifications of the equipment and wires used for wiring.

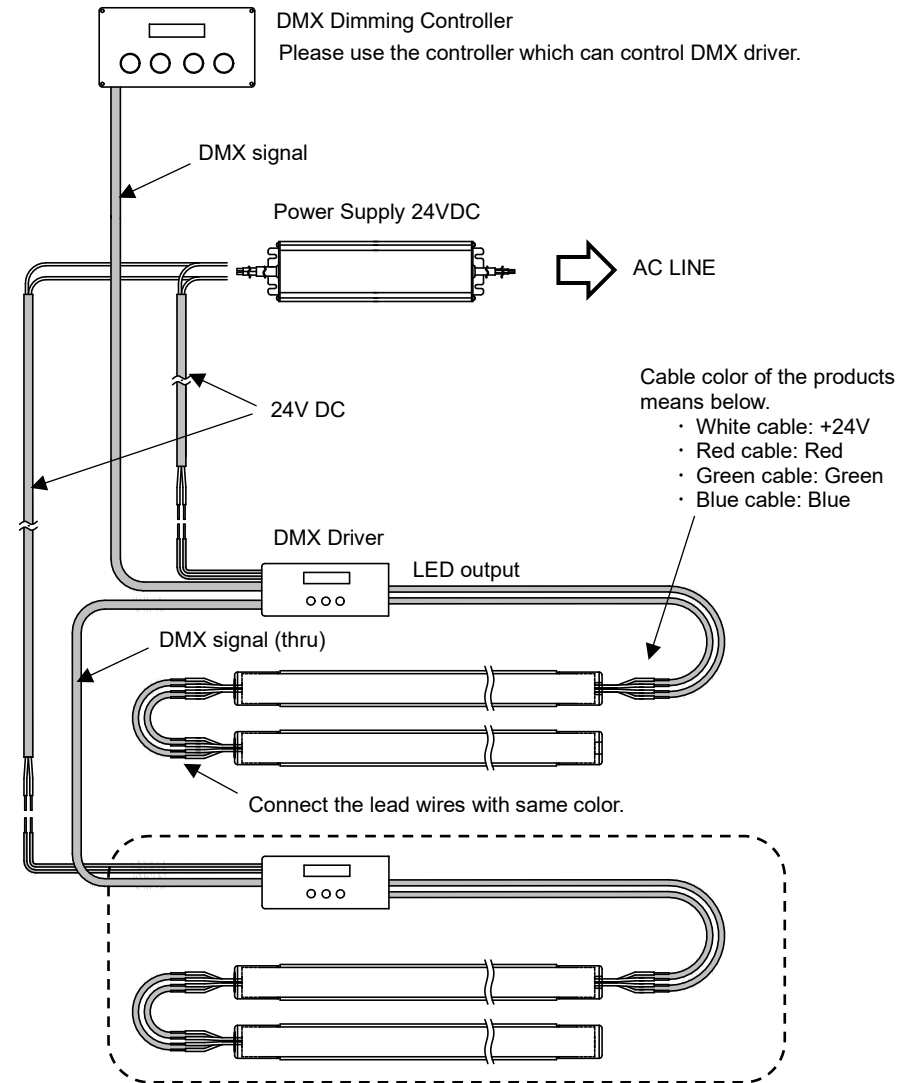

- Divide the wiring in parallel not to exceed the "Maximum series connection length" and the "Limits of current value and wires".

How to cut the product at site

CAUTION

- After cutting, completely remove chips from the cross section. It may cause a short circuit.
- After cutting, it is necessary to treat it with the End Cap, to prevent smoke and ignition due to electric short or leakage, and to keep waterproof performance.

- When you have to shorten a length of the product, it can be cut at every 57.0 mm. For the positions that can be cut, refer to the item of "Dimension".

- Purchase optional End Cap (EC109-02) separately.
- Once the product is cut off, it cannot be repaired. Before cutting the product, ensure the cut mark.
- Using without End Cap may cause electric fault, fuming or fire.
- Diagonally cut may cause a failure of the product or prevent an attachment of End Cap.
- Damages and failures which caused by your cutting are not covered under the warranty.

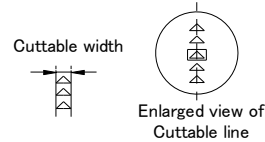

1. Determine the cut position.
2. Cut on the mark "△" correctly.
3. Make sure there are no chips or fragments on the cut section.
4. After cutting, cover the cutting point with End Cap.

Installation Method

WARNING

- Be sure to fix the channel to the wall, and fit the product into the channel. There is a risk of falling if they are not installed properly.
- When installing the product vertically with the channel, use the appropriate L-shaped bracket to support the product. Otherwise, the product may slide down.
- If the lead wire is sandwiched between the L-shaped bracket and the channel, the lead wire will be damaged and may cause a malfunction or fire. Make sure that there is a gap for the lead wire between the product and the L-shaped bracket, such as by inserting a spacer, so that the lead wire is not damaged.

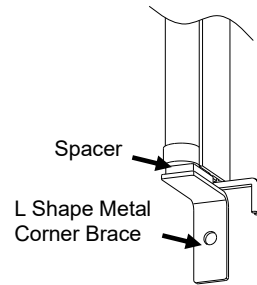

CAUTION

- Use Atex accessories to install the product.
- Do not put the screw on the product directly. It may cause damages.
- Do not use double sided tape and glue to install the product.
- Do not bend the product tighter than the minimum bend radius (R60mm). It may cause the failure.
- Do not perform the excessive bending or twisting of the lead wires and End Caps. It may cause the failure and the decline in water resistant performance.

■ Straight line installations

CAUTION

- When inserting the end cap into the channel, be sure to cut it so that the end cap fits into the notch of the channel.
- Forcibly inserting the end cap into a position that is not the notch of the channel, may cause a malfunction.

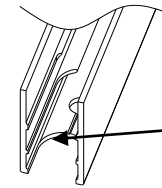

When the end cap is put into the channel.

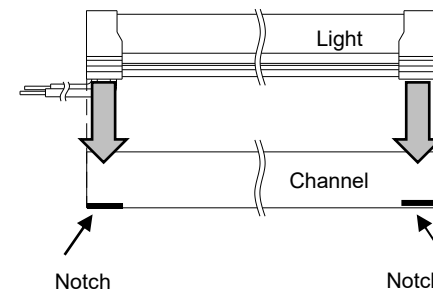

Cut the channel so that the end cap fits the notch of the channel

When the end cap is out the channel.

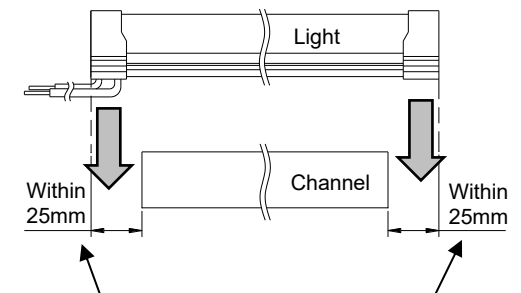

Cut the channel so that the length of the light that sticks out from the channel should be within 25 mm.

1. If you have to shorten a length of the product, refer to "How to cut the product at site".
2. Please cut the Aluminum channel for straight line (FAS00-01GD) as needed.
3. Remove the burr after cutting the channel, because the burr may cause damages, electric shock and smoke.
4. Securely mount the channel on the wall using screws and screw holes.
•Please use the appropriate screws according to the wall.
5. Put and push the product into the channel securely.
• Insert the product ribs securely below the channel ribs.

The product ribs should be below the channel ribs.

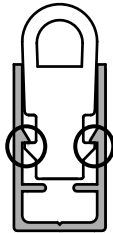

6. After attaching the products, pull them to make sure they are completely fixed in the channel.
Otherwise, the products may be dropped off from the channel.

■ Curvy line installations

- Use Aluminum channel for flexible line (FAC20-01GD).
 - The basic mounting method is the same as for straight lines.
1. Please cut the channels as needed.
 2. Curve the channels along the wall, and securely mount them on the wall with screws. Please use the appropriate screws according to the wall.
 3. Then, install the product into the channel.

■ In case of removing from the channel

- We DO NOT recommend to remove the product from the channel after the installation. Repeated installation and removing may causes failure.
- If you have to remove the product from the channel, lift up the product carefully and slowly, and pull it out vertically within 45 degrees with your hands.

